

UNIDOR – the program

Products for perfect punching and forming

– Systems

– Retrofits

– Components

– Sensors

– Services

TR-Electronic GmbH Campus Trossingen



Contents

Everything you need for punching & forming.....	4	compactPRESS smartLINE.....	14
Retrofits.....	6	Components.....	15
Systems.....	7	Tool and machine protection.....	17
Software.....	8	Sensors.....	18
Controls.....	9	Connection boxes.....	21
Overview of controls.....	10	Services / project management.....	22
powerPRESS starLINE.....	12	Sales.....	26
compactPRESS ecoLINE.....	13		

TRsystems GmbH, Unidor System Division in Pforzheim



Company history

1948 – Establishment of Kiefer KG, watch and metal goods factory, Pforzheim

Creation of the UNiDOR brand name. Through automation of punching processes. In-house development of the first tool protection systems (UN series) and optical sensors.

1971 – Sale to Thurn and Taxis

Further development of systems, driven by constantly new challenges. Introduction of the first force monitoring systems. Creation of the APS system, development of the first axis automations (stroke adjustments; ram adjustments).

1990 – Acquisition by the Prym Group

Further development of the APS system, first industrial PC systems are used. Customer-specific solutions are increasingly implemented.

1996 – Acquisition by TR-Electronic GmbH

Creation of the Aplus system. In 2000 creation of the compactPRESS system. 2012 integration into TRsystem GmbH.

unidor is more than the sum of its products

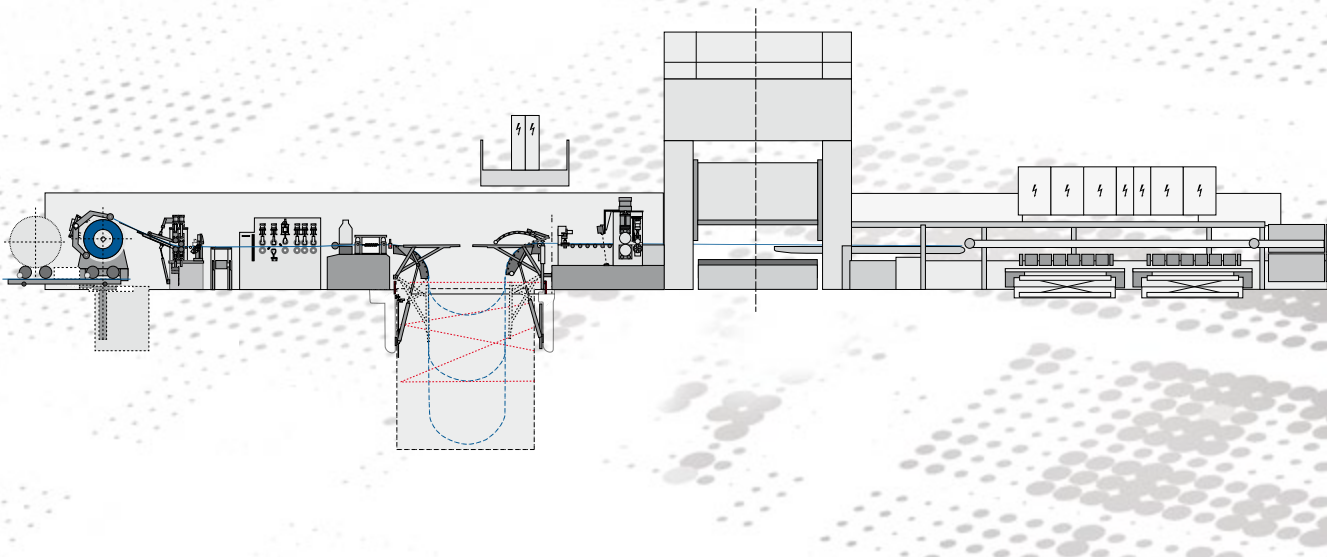

We provide: Products for perfect punching and forming

Together. Quality products in cutting-edge technology are one thing. Our longstanding experience in process optimization for punching and forming is another. So don't just see us as a supplier of systems, retrofits, components and sensors, but also as a team of experts with extensive practical experience and plenty of optimization ideas.

We want to work with you to establish a status in production, machine and tool. We will then produce an expert's report to show how the complexity of your products, productivity and quality can be increased with existing resources and new concepts.

See us as experts who will work with you in close partnership to create opportunities to get more out of production, and to produce more efficiently and reliably with your machines and tools.

From UNiDOR you can expect an integrated all-round package

From neutral expert advice to prompt delivery and installation of the optimal technology, as well as long-term and consistent after-sales service. Use our forums and presentations to remain constantly up to date. Let us seek optimal solutions in a long-term partnership and inspire each other to constantly push the limits of the possible.



Technology leader and quality from the very start

Forwards. The future of punching and forming is changing rapidly: it is becoming more complex, faster, more precise, with complete documentation, up to the highest number of strokes. Innovative product requirements by your customers and continuous cost pressure force you to take product and tool to the limits of feasibility on a daily basis.

It is therefore becoming increasingly important to visualize the punching and forming process, in order to optimize and precisely control every work step on this basis. Precise understanding of the process is essential to fulfill the customer's requirement for perfect production and quality products and to create the technological lead that will secure orders today and, even more, tomorrow. UNiDOR provides perfect products, an abundance of ideas and a range of services to meet this need.

From special sensors to monitoring devices and user-friendly, universal measuring systems, we have exactly the equipment that you need to have punching & forming permanently under control, both in detail and overall. With our products you can be sure of reliably managing the production process even at the limit of technical capabilities, and of always achieving excellent results with maximum cost-efficiency.

Retrofits

Consult us

In mechanical engineering

Together with our competent mechanical specialists we will ensure a compact mechanical, hydraulic and electrical upgrade of your machine.

- _ Brief interruption in operation
- _ No structural modifications (foundations)
- _ Expenditure can be written off immediately

Anyone who needs cost efficiency, needs us

- _ Current machine status
- _ Expertise in general electrical overhauls
 - Switch cabinet + control panel
- _ Control PLC S7 (as HardPLC or SoftPLC)
- _ compactPRESS starLINE or ecoLINE
- _ Complete electrical equipment + installation
- _ Handover + acceptance with safety check
- _ Training + service + spare parts

Refurbishment, general overhaul, modernization - many names for the same objective

Presses and punches are durable capital goods, whose life cycle goes beyond the control, peripheral equipment, actuators and sensors. Why always think about buying a new machine, when you can still earn a lot of money with the old one, at modest costs!

This solution also has tax advantages, because overhauled machines can be written off more quickly! Modernization costs can be depreciated immediately.

An overhauled punching press will enhance the image which you present to customers and ultimate buyers just as much as a new one! The performance and look of a perfectly overhauled punching press is in no way inferior to a new one!



Systems

compactPRESS – the process monitoring system for punching and forming technology

A wide variety of controls ensure the broad range of functionality and universality of compactPRESS. Everything that is important for an optimal and continuous production process is displayed, reported and monitored by compactPRESS with the utmost precision. compactPRESS, comprehensive insurance for machines and tools.

compactPRESS

- _ is your all-round assistant for practically everything, a professional for measuring, controlling and rationalizing punching & forming. Ultra-fast up to the highest number of strokes,
- _ protects your machines and dies, ensures regular maintenance and service, manages, logs and archives all production and quality data,
- _ offers simple touch-pad operation that everyone can easily understand. Icons instead of buttons guide and inform the operator in every situation. Knowing what's going on has never been easier,
- _ is based on an extremely reliable IPC. The best solution for continuous machine-level operation in harsh conditions,
- _ displays what is going on in the machine and die directly at the machine or via a central control panel. No matter where your machine is producing, you have everything in view at all times,
- _ understands all analog or digital sensors and combines them as required, functionally, logically or mathematically,
- _ as a standalone system primarily in retrofitting or as PLC subsystem of a control in the initial equipment,
- _ increases the availability of tool and machine and ensures greater transparency, particularly in critical production processes with difficult materials.

However, the immense range of functionality and performance of compactPRESS is determined by the extremely flexible controls. Controls are software-based action and functional units, special „tools“ for all tasks and applications in punching & forming.

The controls determine the numerous features for visualizing, measuring, optimizing, monitoring and logging. With the compactPRESS controls you always know exactly what is going on; production processes, machine and die become so transparent that they take you to the limits of the possible. Whatever the task in hand, with compactPRESS you will find the right control or controls. Each of the many controls is designed for a specific task. Tasks which you can easily solve in many areas by means of parameterization.

In conjunction with specific sensors you now have a set of tools that will provide you with comprehensive support in all customer requirements for greater complexity, precision, productivity and quality, defining entirely new production dimensions in punching and forming.

After an overview of all currently available controls for ecoline+starline, we will provide detailed examples of our own controls and show practical applications.

Two software packages, compactPRESS ecoline and compactPRESS starline, are available. Ecoline is the entry-level class, starline is the high-end performance class. Upward compatibility for data and variables from ecoline to starline is guaranteed.

compactPRESS understands all sensors, regardless of whether digital or analog sensor signals are involved. The same applies for a wide range of absolute rotary encoders, whose inputs are easy to parameterize.

This also applies for digital and analog outputs.

Ample scope for convenient I/O handling.

Software for model series 169



Fig. 1

Side panel

Important displays can be dragged from the main screen onto the side panel using „Drag and Drop“. If more displays are configured than can be shown on the side panel simultaneously, you can scroll the desired display up and down with your finger (Fig. 1, red arrow) (device example: Notion).

Graphic programming of the envelope curve

Beginning, end, maximum and minimum limit of the envelope curve (Fig. 2 & 3) can be programmed with a finger click. To do this, select the tool icon in the individual curve display of an analog channel. After selecting the respective icon, the desired limits can be changed by dragging with the finger.

Fig. 2



Abb. 3



Controls

Basic Controls

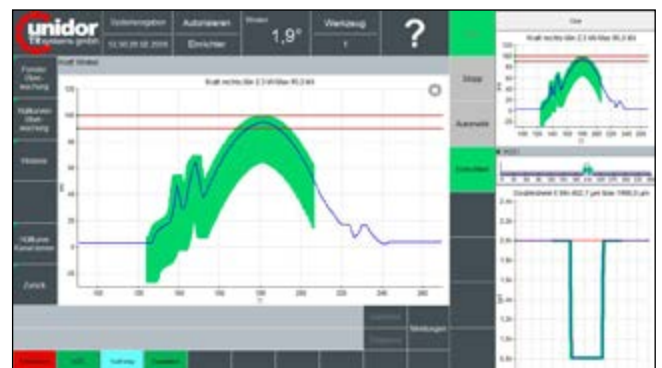
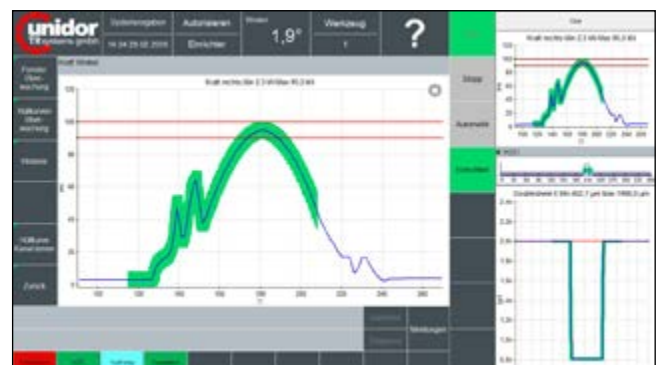
The heart of every compactPRESS is the integrated smartPLC. It links the controls, coordinates the timing and organizes all processes of compactPRESS.

Visualization and parameterization of the controls occur in the control itself, depending on the function and task. The real-time core guarantees correct execution of all time-relevant tasks. All controls included in this group organize and manage compactPRESS.

Digital Controls

This group includes all controls for digital signal processing. All common digital sensors may be used as signal transmitters.

Analog Controls

This group includes all controls for analog signal processing. Special analog sensors are increasingly used in punching and forming technology, and compactPRESS provides the optimal evaluation.

Measuring Controls

This group includes all controls which continuously measure and monitor the supplied material and the production process. Important controls for quality optimization and comprehensive QA certification.

Process Controls

This group includes all controls relating to the production process. Intelligent controls which leave nothing to chance, from material supply through to product selection.

Management Controls

This group includes all controls which manage data, information and actions: Tool log, maintenance organization, import and export, automatic action timing ...

Interface Controls

This group includes all controls which guarantee simple and safe communication between compactPRESS and peripheral systems.

OEM Controls

This group includes all controls which ensure problem-free connection of external equipment (OEM systems).

Tool Controls

This group includes all controls which produce variable products completely automatically with intelligent tools. Ideally suited for automating die controls.

Position Controls

This group includes all controls which can be used as position encoders in compactPRESS.



The right control for every task, a wide selection

Basic Controls	
User administration	System log-on, user identification
Die management	Creation of up to 1000 tools, configuration, saving and backup of tool data
Message management	Internal information, warnings, error display, acknowledgement and deletion
Color management	Free color design of cP screens
Language management	Language file and language selection
System setting	System management, language selection, machine type, machine ID, date/time
Help system	Context-sensitive help for all processes
Digital Controls	
Cam switchgear	Up to 128 cams assignable
Tool protection	Up to 64 digital tool protection devices
Counter	Up to 32 universal counters, counting pulse source is freely selectable
Positioning	Up to 8 positioning axes (multi-turn encoder): ram, strip inlet, feed etc.
Analog Controls	
Force angle	Up to 32 channels for machine and tool force
PSA (Piezo Signal Analysis)	Up to 20-channel individual measurement in the tool for force and deformation
Double blank (slug) monitoring	Up to 32 channels for double blank or slug detection. UT measurement and more
Structure-borne sound	Up to 32 channels for structure-borne sound
Measuring Controls	
Analog feed measurement	Measurement of feed travel, strip position in tool
Strip width measurement	Check strip material for parallelism, curvature, etc.
Strip thickness measurement	Absolute measurement of strip thickness
Part measurement	Measure 100% parts in the process: height, thickness, diameter, angle etc.
Dimensional check	Check parts in the feed phase
Process Controls	
TDC stop	Controlled stop at TDC (top dead center)
Stroke adjustment	Automatic adjustment of stroke height
Stroke table	Stroke-dependent angle correction
Ram adjustment and display	Automatic adjustment of the ram axis
External die change	Automatic transfer of the tool number from higher-level systems
Sorting	Intelligent separation of bad parts (shift register principle)
External error message	Records all external errors or faults, as binary or 1 from n coded messages

μBDE	Operating and production data for central EDP
Management Controls	
Notebook	Prolog, space for any information on machine and tool
Data import and data export	Import drawings and export cP docs to any host systems
Archiving of process data	Export of information and data in Excel csv or QS-Stat format
Maintenance & service	Interactive management and schedule for functions and actions
Interface Controls	
Lubricating system control	Programming, visualization and measurement of lubricant quantity
Open OPC interface	OPC client for communication with peripheral systems
Feed interfaces	Transfer of feed parameters, display of values and control buttons
Zehnder & Sommer	
Indramat	
Bosch Rexroth	
P.A. Automation	
Esitron	
Interfaces for PLC control	For communication with S7-PLC (hard or soft PLC)
Profibus	
Profinet	
IBH Netlink	
Tool Controls	
Tool-dependent PLC	Customized signal combination
Die control	Order-dependent calculation of die control and feeds
Cylinder monitoring	Cylinder control with limit position monitoring
Servo positioning	Up to 4 axes in the tool
Position Controls	
Rotary	Recording of X axis in 0.1°
Linear	Recording of X axis in 0.01 mm
Temporal	Recording of X axis in 200 μsec
Virtual encoder	Simulation of a rotary encoder via an input signal

powerPRESS with S7-PLC & starLINE

powerPRESS, the complete automation solution

powerPRESS is operation, control (PLC) and compactPRESS in one: An integrated automation concept for all machines for punching & forming.

powerPRESS not only boasts excellent technology, but also impresses through its economical use of just a few hardware components: A touch display for the machine operation and compactPRESS visualization, an IPC for the PLC (S7), the drive and compactPRESS: In short, an „all-in-one“ automation solution par excellence.

The I/O handling between sensors/actuators and IPC is enabled via EtherCAT (fieldbus), which provides the basis for ultra-fast signal transmission of analog and digital measuring values. The number of I/O terminals (sensors/actuators) is scalable.



Panel PC 15,0"

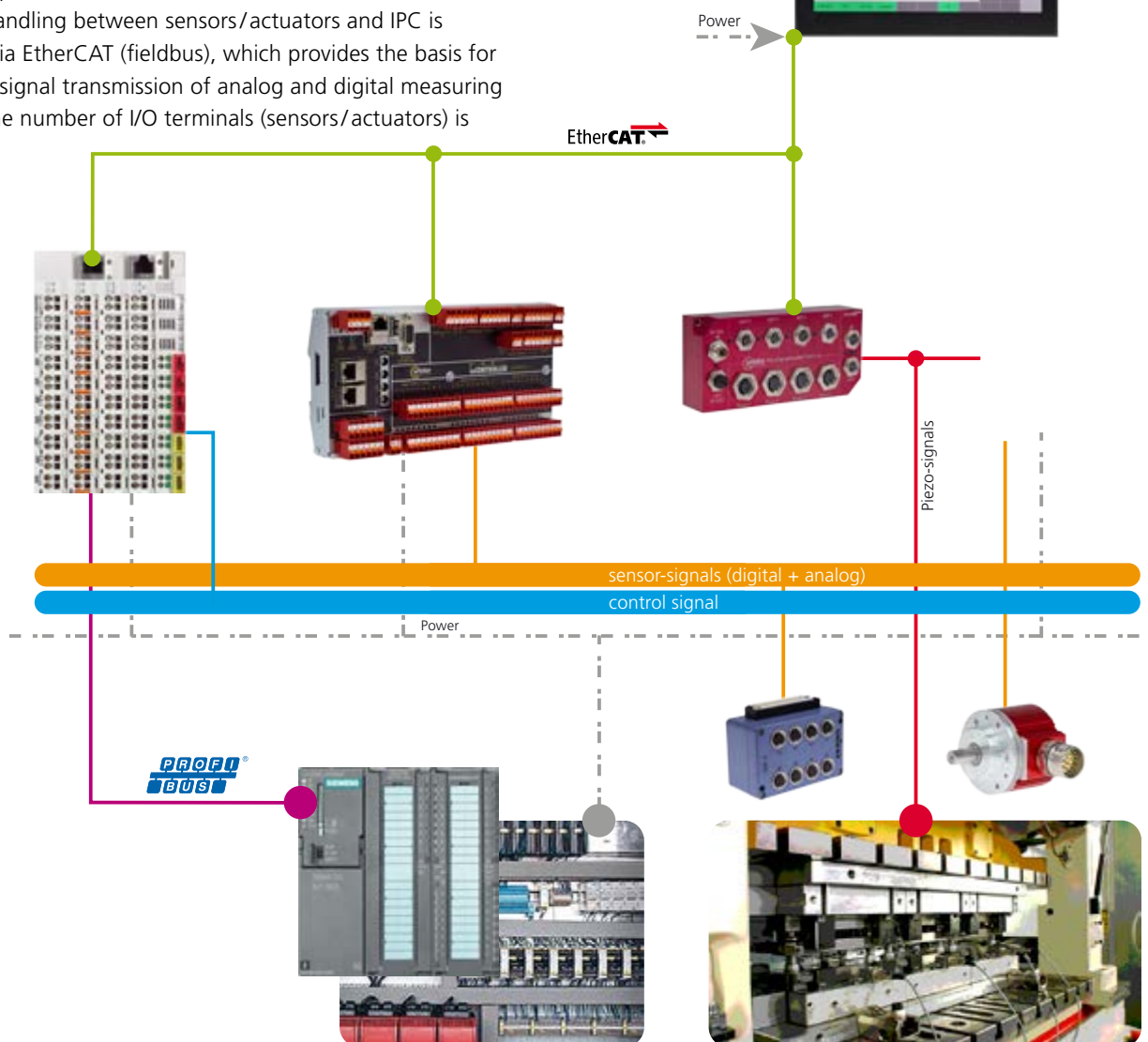

The medium compactPRESS: ecoLINE

The medium ecoLINE

ecoLINE, for universal intelligent process monitoring for stamping & forming.

ecoLINE based on a robust embedded touch screen PC, a 15" built-in device which is mounted in front panels. The 10.4" desktop device can also be used.

The I/O handling between sensors/actuators and PC is enabled via EtherCAT (fieldbus). This guarantees fast signal transmission of analog or digital measuring values. The number of I/O terminals (sensors/actuators) is freely scalable.

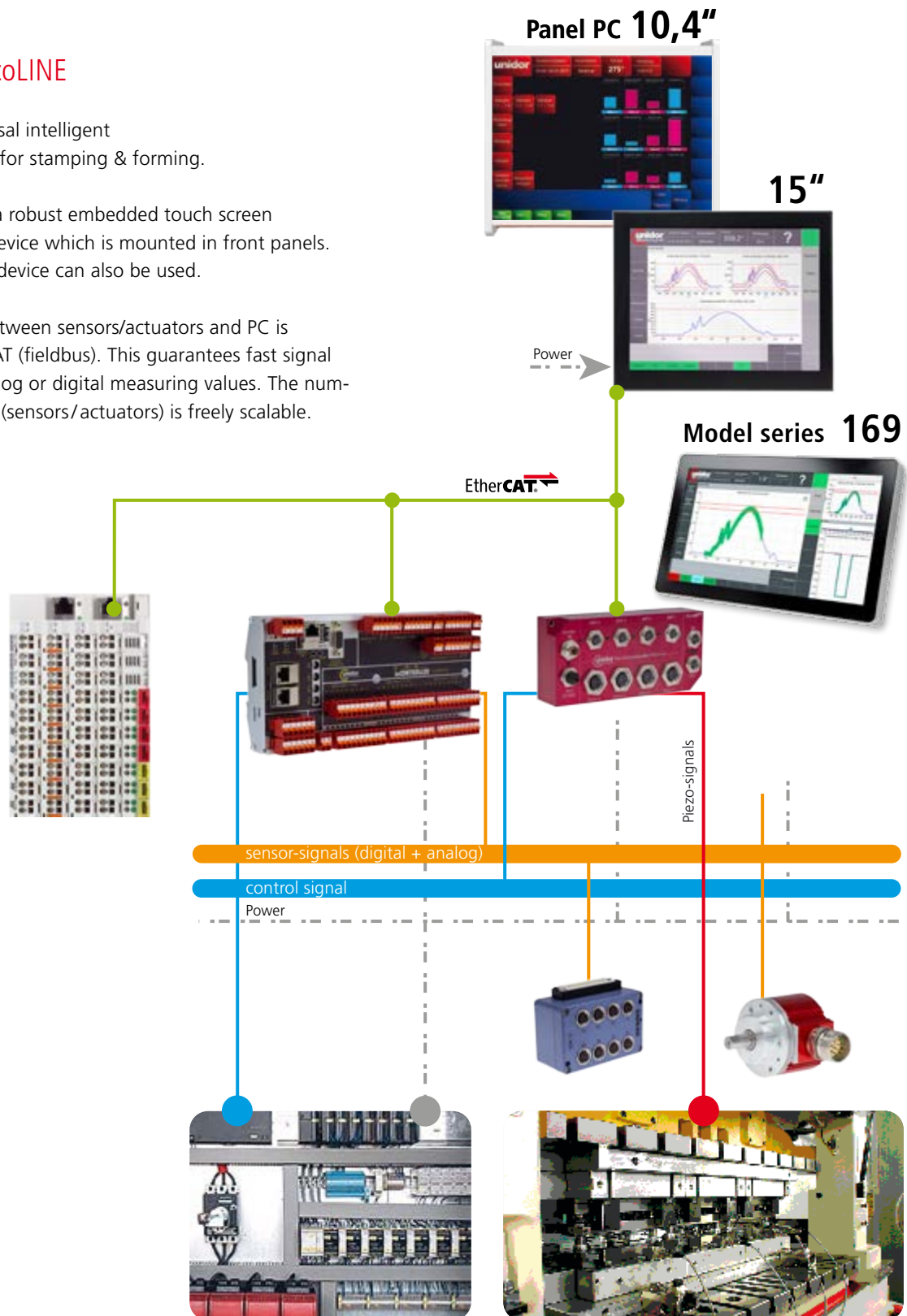

The small compactPRESS: smartLINE

The small smartLINE

smartLINE is the perfect, low-cost introduction to intelligent process monitoring for stamping & forming.

smartLINE is based on a robust embedded touch screen PC, a 10.4" desktop device which will fit anywhere without the need for mounting.

The I/O handling between sensors/actuators and PC is enabled via EtherCAT (fieldbus), which guarantees fast signal transmission of analog or digital measuring values. The number of I/O terminals (sensors/actuators) is scalable within limits.

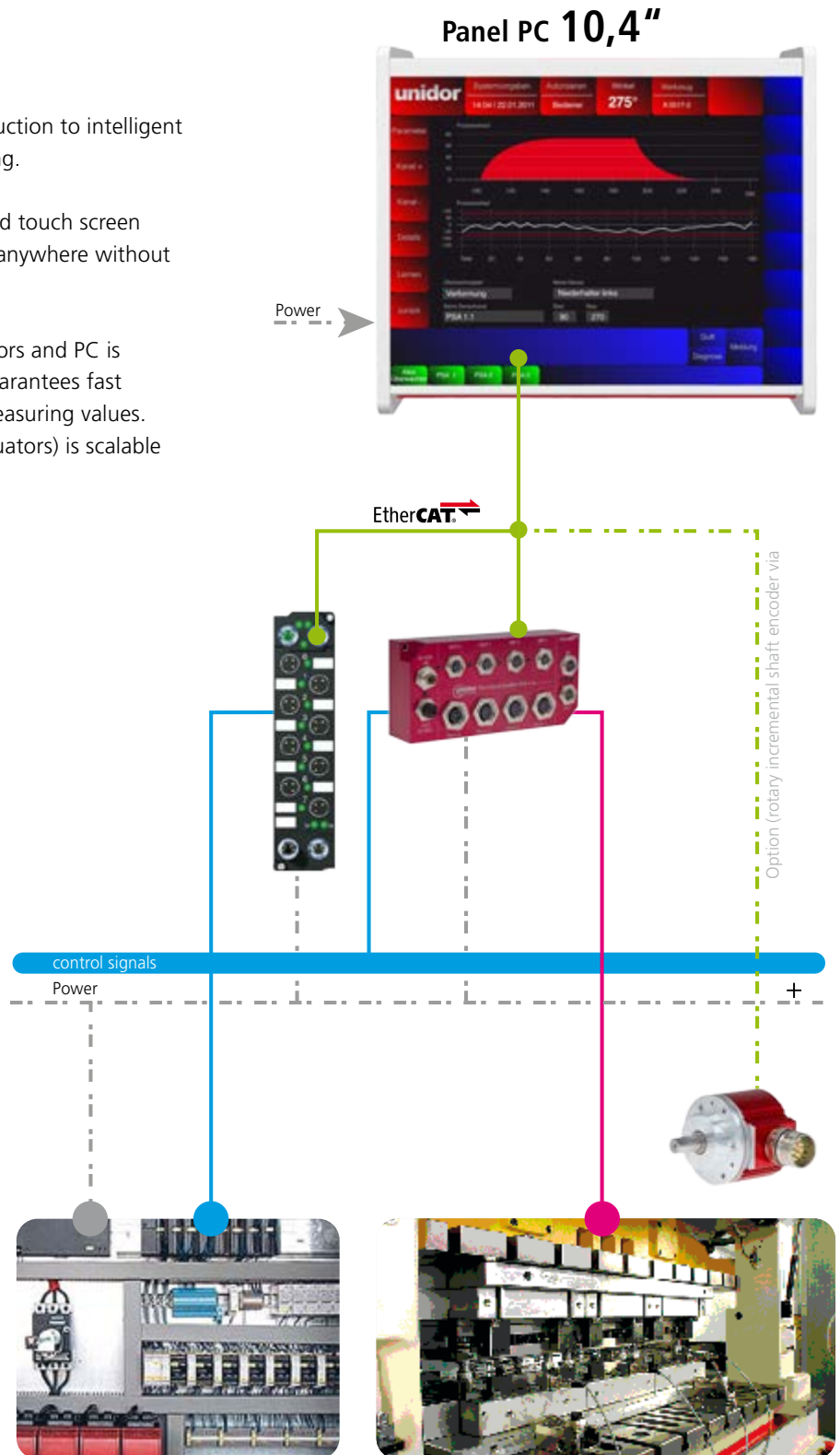

Components / standalone devices

ioCONTROLLER

This is suitable for all automation tasks which cannot be performed with a PLC or only with significant cost/effort, or which are simply too slow for a PLC.

With its robust hardware and simple system integration the ioCONTROLLER can be seamlessly integrated into any PLC project. It performs all special tasks which a PLC cannot, precisely and ultra-fast.

The ioCONTROLLER begins where the PLC ends and opens up a whole new spectrum of opportunities for many interesting and creative automation ideas.

We give a few examples to show where and how the ioCONTROLLER can support the machine control, enabling entirely new options for greater productivity, quality and transparency in production.



Analog-IN box

To supplement compactPRESS control systems, UNIDOR also offers input modules.

The analog box imports up to 16 analog inputs (0 ... 10 V, 0/4 ... 20 mA) and transmits them via EtherNet/IP or PROFINET. The box is supplied with voltage via specially coded M12 plug connectors. This effectively excludes confusion with the bus cables.

The voltage supply is looped through, so that several modules can be interconnected directly in series.

The bus is connected via standard-compliant M12 plug connectors. The sensors are connected via M8 and are also directly supplied via these connections. The analog box can also be used directly in the field with this equipment.



Components / standalone devices

LVCpro 02-S charge amplifier

New - now also suitable for quasi-static measuring processes such as servo /hydraulic presses.

With the newly designed, compact charge amplifier cassette LVCpro 02-S, a multi-channel measurement of the press force can be performed cost-effectively using piezo sensors. An evaluation can be carried out by any higher-level control with an analog input, e.g. Unidor systems (power-PRESS & compactPRESS) or external PC and PLC systems.

Applications

For machines and devices, for measuring dynamic and quasi-static forces, primarily in press manufacture. The necessary piezo sensors are prefabricated in different designs and supplied by Unidor.



PSA 4ec

The PSA ec4 piezo signal amplifier is a perfect 4-channel amplifier specially for piezo sensors, such as pressure, force, acceleration or torsion sensors in all technical applications and areas.

The robust aluminium housing and the high IP67 protection class qualify the use of the PSA in industrial environments in particular and guarantee continuously safe operation.

The EtherCAT®-compatible PSA has 4 analog precision piezo measuring channels (charge amplifiers) including two digital inputs and outputs. The intelligent charge amplifiers are triggered via EtherCAT® with PLC or PC. The extremely low drift of the input stage and the digital processing of the charge signal enable not only very precise, but also quasi-static measurements.



Tool and machine protection

Connect, switch on and control and monitoring of tool and machine begins straight away: all very simple.



Tool protection – smartDIE-PRO 6 6-channel digital tool protection with learning function (Teach-In) and graphic event viewer

Safe hardware, safe software. This dual safety concept ensures maximum system availability and trouble-free operation. Redundant, error-tolerance data storage management and intelligent power control ensure an extremely safe system.

All at a price that will convince you of our tool monitoring entry-level system.



Tool and machine protection – PKM 2.000

Continuous monitoring and display of press force. The force is detected with piezo sensors on the machine or tool. The evaluation system has two channels. In case of overload the system is switched off. Replacement for Imco devices. Direct exchange possible.



Overview of sensors

Sensors

Right at the heart of the action, sensors convert mechanical quantities such as ...

- _ Force
 - _ Pressure
 - _ Sound
 - _ Vibrations
 - _ Travel
 - _ Positions
 - _ Movement
- ... into digital or analog signals.

These form the basis for exact visualization, optimization, measurement, monitoring and logging of all punching and forming processes.

Our sensors have been specially designed for punching and forming.

Unidor provides a wide range of sensors in different designs, complete with the appropriate mounting equipment.

Digital single-beam sensors



GD_L

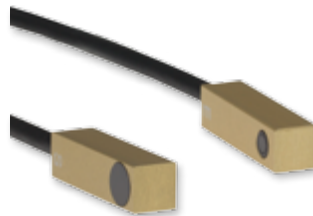

LS 05



LAS 3

Digital multi-beam sensors



LAV



LAG

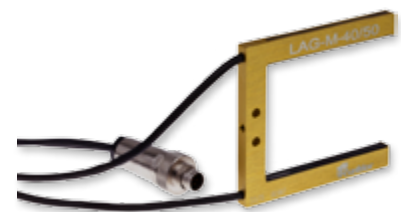

LAG-M

Reflex scanners



GM



ORS 250



ORS 400-W

Analog sensors



GD-AH

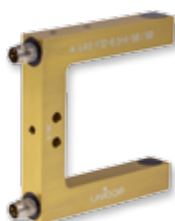

A-LAS



LAG M40

Digital, inductive sensors

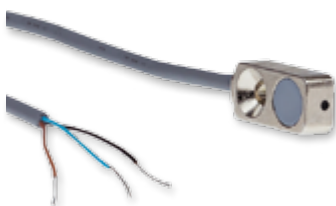

ZT 52



ZT 400



ZT 410

Overview of sensors

Analog eddy-current sensors

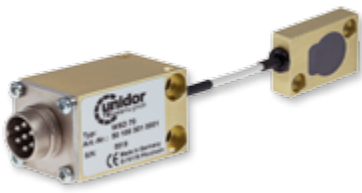

WSD 70



WSD S2/10 S

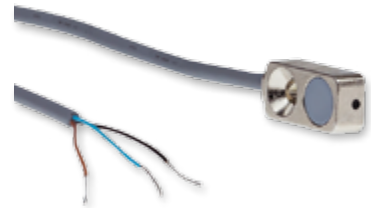

WSD S2/10 M-F

Piezoelectrical sensors



JZT 127



PSA 20



QMD

Other sensors



Tracer GM 04



OKT 40



Structure-borne sound KSS

Connection boxes

Digital connection boxes



8-channel tool protection box
ZT 2013 (ZT 213/72/8)



4-channel tool protection box
ZT 2013 (ZT 213/7/4)



ND (12/8/4)

Analog connection boxes



D-AE-WSS-24
8-channel for WSD-sensors



Distributor box
8-channel, M12, 5-pole



Actuator / sensor box
ASD 4/0/8, 8-channel

EtherCAT fieldbus connection boxes – EtherCAT box



EP1018-0001
8 digital inputs, M8



EP2008-0001
8 digital outputs, M8



EP3174-0002
4 analog inputs, M12, ± 10 V

Services / project management



Sales

Pre-Sales Services

Pre-sales services, in-depth consultation, the development of individual proposals, planning services and the individual requirements of the customer are analyzed and integrated into the project.

After-Sales Services

Our sales representatives aim to continue to support their customers after the sale, to ensure customer satisfaction.

Service

- _ 3 locations in Germany
- _ Highly motivated service technicians
- _ Telephone support/remote maintenance

We implement our „Everything from one source“ concept, which includes comprehensive service. Our trained staff will be at your disposal quickly and flexibly in all areas – around the clock, including weekends.



Ready for all requirements

Our range of services also includes the inspection of electrical systems and equipment. We want you to be able to continuously rely on the solutions that we have developed for you in daily practice. You will benefit from the same expertise and reliability that we apply in our numerous projects. And what's more: You can also rely on our experienced staff to ensure the regular maintenance and service of your systems – to support or replace your own personnel. As always – our service offering is entirely based on your requirements.

Training

Your employees are an important factor for your company's success. They must be supported and challenged, so that they can develop their full potential through the acquisition of additional qualifications and in-depth knowledge. Unidor offers: Individual training on site; directly at the machine or in customized workshops at our Pforzheim and Lüdenscheid locations.

TR-Electronic – your partner in automation

Rotary encoders

Absolute encoder, incremental rotary encoder, wire-actuated encoder

Rotary encoders with optical and magnetic scanning function register the precise position in a wide variety of applications and industries. In medical engineering, miniature versions ensure correct positioning while SIL3-approved absolute rotary encoders provide the necessary safety. We offer not only high-quality rotary encoders (from Ø 22 to 160 mm) for almost any application but also comprehensive accessories.

Linear encoders

Linear absolute measuring systems, laser displacement measurement

Linear encoders register linear motions in machines, tools and systems according to specific requirements using different technologies. Linear encoders allow measuring distances of max. 20 m almost without any wear. This value is max. 240 m for laser measuring systems. Machines and systems can be precisely controlled to reach their desired positions.

Motion

Servo drives, compact drives, process drives

Intelligent encoTRive drives are available with the current field bus systems, such as PROFIBUS, PROFINET and CANopen, within a power range of up to 300 watts. The drives are configured to meet customer requirements and can be freely combined with precision gear, holding brake and I/O. Values of up to 4,350 rpm and powerful 200 Nm are available to cope with demanding applications.



Components

Industrial PC, field bus I/O, PLC, HMI controller

Industrial PCs are available in numerous variants and offer customized calculation power for PC-assisted automation. Programmable logic controllers (PLC) are the traditional means for automation. HMI controllers establish the interface to the user. Field bus nodes, I/O modules and cam controllers complete the range of automation components.

Automation

Consulting and implementation for new machines and retrofit

You want to set up a largely automated new machine or retrofit and modernize your existing machine with automation systems? Then you just need our extensive expert knowledge and the more than 20 years of our experience.

Unidor

Blanking and forming, systems, controls and sensors

Trendsetting blanking and forming technology for more than 30 years. We are your reliable partner in the world of blanking and pressing and can prove this with thousands of machines which we have successfully installed all over the world. Sensors, controls and systems ensure optimal results in machines, tools and retrofit projects.



Germany

TRsystems GmbH

Systembereich Unidor
Stammhaus Pforzheim

Freiburger Straße 3
D-75179 Pforzheim

Tel.: +49(0)7231-3152-0
Fax: +49(0)7231-3152-99

unidor@trsystems.de
www.unidor.info

Australia

BRUDERER PTY LTD.
Unit 18/2
Railway Parade
AUS-Lidcombe NSW 2141
Tel.: +61/29-749 2700
Fax: +61/29-749 227

Canada

TR Electronic Inc.
P.O.Box 2543 ,Station B
London , Ontario, N6A 4G9
Tel.: +1/519 4 52-19 99
Fax: +1/519 4 52-11 77
customercare@trelectronic.com

Israel

DOR Drive Systems L.T.D.
P.O.B. 6 Kibbuz Einat
49910 Israel
Tel.: +972/3 9007595
Fax: +972/3 9007599
sales@dor1.co.il

Italy

TR Systems Italia srl
sig. Fabrizio Favero
Via Brescia, 2
I-25030 Berlingo (BS)
Tel.: +39/30 9973094
Fax: +39/30 9787629
Mobile: +39/335 6882641
fabrizio.favero@trsystems.it

Austria

TR-Electronic GmbH
Tragösserstraße 117
A-8600 Bruck/Mur
Tel.: +43/3862-550 06
Fax: +43/3862-55006 33
info@tr-electronic.at

China

TR-Electronic (Beijing) CO., LTD
RM. 1613, Side A, Lucky Tower
No. 3 Dongsanhuan North Road,
Chaoyang District
CN-100027 Beijing, P.R.China
Tel.: +86/10 646 131 96
Fax: +86/10 646 135 51
lu.yu@tr-electronic.de

Denmark

TR-Electronic Danmark ApS
Hustedgardvej 22
DK-8722 Hedensted
Tel.: +45 (0)75 89 06 03
Fax: +45 (0)75 89 06 36
cbj@tr-electronic.dk
www.tr-electronic.dk

Telestar S.r.l.
Via C. Colombo 13
I-22069 Rovellasca (Co)
Tel.: +39/2 96 74 02 68
Fax: +39/2 96 74 02 73
telestar
@telestar-automation.it

Belgium

F. Hoffmann B. V.
Gildenweg 25-35
3334 KC Zwijndrecht
Tel.: +31/7 8610 23 88
Fax: +31/7 86 10 32 55
info@hofmann-machines.nl
www.hoffmann-machines.nl

Czech Republic

DEL A. S.
Strojirenska 38
CZ-59101
Zdar Nad Sazavou
Tel.: +42/566 642 257
Fax: +42/566 621 657
del@del.cz

Finland

OYE.Sarlin AB
P.O.Box 750
SF-00101 Helsinki 10
Tel.: +358 (0)950 44 41
Fax: +358 (0)9563 32 27

Japan

Unitechnology Co. LTD
Fuji-jingu Bldg. 902
1-11-6 Yokota, Atsuta-ku
NAGOYA 456-0022
Tel.: +81/52 678 8002
Fax: +81/52 678 8003
info@unitechnology.biz
www.unitechnology.biz

Brazil

Autron Automação Indústria
Comércio Ltda.
Rua Cons. Brotero,
589 - 10ªa
BR-04105-001 São Paulo - SP
Tel.: +55/11 824-01 09
+55/11 825-04 69
Fax: +55/11 825-23 83
info@ctecnologia.com.br

Great Britain

BRUDERER UK LTD.
Cradock Road
GB-Luton. Beds LU4 0SF
Tel.: +44/1582 560 300
Fax: +44/1582 570 611
mail@bruderer.co.uk

France

TR-Electronic France
56, Boulevard du Courcerin
F-77183 Croissy- Beaubourg
Tel.: +33 (0) 16462-1313
Fax: +33 (0) 16462-2002
info@tr-electronic.fr

Malaysia

Mongkol Engineering
Block 204
Hougang Str. 21
Singapore 530204
Tel.: +65/648 13678
Fax: +65/648 13679
mongkol@singnet.com.sg

Mexico

TR Electronic Inc.
P.O.Box 2543 ,Station B
London, Ontario, N6A 4G9
Tel.: +1/519 4 52-19 99
Fax: +1/519 4 52-11 77
customercare
@trelectronic.com

Netherlands

F. Hoffmann B. V.
Gildenweg 25-35
3334 KC Zwijndrecht
Tel.: +31/7 8610 23 88
Fax: +31/7 86 10 32 55
info@hoffmann-machines.nl
www.hoffmann-machines.nl

Poland

Stoltronic-Polska Sp.z.o.o
ul. Pontiatowskiego 9/4
PL-87-100 Torun
Tel.: +48/56 651 0385
Fax: +48/56 651 0384
stoltronic@stoltronic.pl

Portugal

Intertronic Internacional, S.L.
Azagador de la Torre, 67
E-46006 Valencia
Tel.: +34/96 3 75 8050
Fax: +34/96 3 75 1022
info@intertronic.es

Singapore

Globaltec Pte. Ltd
50, Bukit Batok Street 23
#06-27 Midview Building
Singapore 659578
Tel.: +65/626 79188
Fax: +65/626 78011
globaltec@pacific.net.sg

Slovakia

DEL A. S.
Strojirenska 38
CZ-59101
Zdar Nad Sazavou
Tel.: +42/566 642 257
Fax: +42/566 621 657
del@del.cz

Spain

Intertronic Internacional, S.L.
Azagador de la Torre, 67
E-46006 Valencia
Tel.: +34 (96) 3 75 80 50
Fax: +34 (96) 3 75 10 22
info@intertronic.es

Sweden

TR-Electronic Sweden AB
Djursholmsvägen 50A
Box 3038
S-183 03 Täby
Tel.: +46 (08) 756 72 20
Fax: +46 (08) 756 76 80
mailbox@trelectronic.se

Switzerland

TR-Electronic SA
14, Ch. Pré-Fleuri
CH-1228 Plan-les-Ouates/Genève
Tel.: +41/22-7 94 21 50
Fax: +41/22-7 94 21 71
info@tr-electronic.ch

Thailand

Mongkol Engineering
Block 204
Hougang Str. 21
Singapore 530204
Tel.: +65/648 13678
Fax: +65/648 13679
mongkol@singnet.com.sg

Turkey

ÜN VERSA Ç ve DI T C.
MAK. SAN. LTD. T .
Cemal Gürsel Caddesi
No: 11 D: 7
TR-35600 Karsiyaka-IZMIR
Tel.: +90/232 382 23 14
Fax: +90/232 382 23 24
info@universa.com.tr
www.universa.com.tr

USA

TR-Electronic
P.O. Box 4448
USA-Troy , MI 48099
Tel.: +1/248 244-2280
Fax: +1/248 244-2283
customercare
@trelectronic.com

**TRsystems GmbH,
Systembereich Unidor**
Freiburger Str. 3
D - 75179 Pforzheim

Tel. +49 7231 3152- 0
Fax +49 7231 3152- 99

unidor@trsystems.de
www.unidor.info

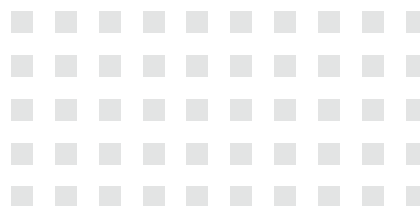

Last update: 01/2017

68-105-118 - UNI-V-PR-GB-0001-01

Subject to technology and design modifications.

Cover photo background: ©kras99-fotolia.com