

**SENSEABLE™**

**SMART BUTTONS, TOUCH OR PUSH SENSITIVE**



**WE CAN STILL CALL THEM - JUST BUTTONS**

More than 8000 varieties of our versatile smart buttons

# Table of Contents

At a Glance .....	3
Features, symbols available .....	4
Comparison of operation principle .....	4
<b>Glossary</b>	
Touch sensitive operation .....	5
Pressure sensitive operation .....	5
Dual color LED-feedback .....	5
Electrical connection .....	5
Internal schematics	
3-pole .....	5
4-pole .....	5
5-pole .....	5
Lifespan .....	5
Robustness .....	6
IO-Link® .....	6
Housing designs .....	6
<b>Operation Modes</b>	
Dynamic mode .....	7
Static mode .....	8
Toggle mode .....	9
Combo mode .....	10
<b>Dimensions .....</b>	<b>11</b>
<b>Technical specifications, Circuits .....</b>	<b>13</b>
<b>Order numbers in detail .....</b>	<b>14</b>

---

## Touch-Buttons - at a glance

The electronic touch button measure the electric field, to detect the presence of a conductive mass for example a hand, finger, grounded metals or liquids.

As soon as a hand or finger touches the surface the button detects the presence and instantly indicates this event. Due to the physical non-pressure detection, operating the switches is very comfortable. Their 100% solid-state design with no moving parts inside allows unlimited operations with no wear. They are not affected by loose clothing, debris etc, objects which accidentally activate optical sensor types.

## Push-Buttons - at a glance

The electronic push buttons utilize a special internal design, to make the sensing face insensitive to conductive mass yet sensitive to applied force. This behavior makes these buttons a perfect alternative to touch buttons which would cause false-trigger when conductive liquids come in contact to their sensing face.



































All buttons come with up to two external inputs to enable the device or to drive the LEDs independently from the internal status of the button.



Features

- Touch or push operation
- No moving parts
- Bright optical dual-color feedback
- 100% water- and oil-tight - IP67
- Vandalism proof design - up to IK10
- Shock resistant - completely sealed
- Up to two external LED-enable-inputs
- Fits into standard Ø22.5 mm mounting holes
- Extreme lifespan  
Several 100 milion operations
- Touch switches have teach-in recalibration feature  
Enables the integrator to change sensitivity on-site

Available Symbols

							
#1	#2	#3	#4 <sup>1)</sup>	#5	#6	#7	#8
							
#9 <sup>1)</sup>	#10	#11	#12	#13	#14 <sup>1)</sup>	#15	#16
							
#17	#18	#19	#20	#21	#22	#23 <sup>1)</sup>	#24 <sup>2)</sup>
							
#25	#26	#27	#28	#29	#30	#31	#32 <sup>1)</sup>
			<sup>1)</sup> for 'TOGGLE' mode only. <sup>2)</sup> for 'COMBO' mode only. Customer specific symbols on request.				
#33 <sup>1)</sup>	#34 <sup>1)</sup>	#35 <sup>1)</sup>					

### Touch-sensitive buttons



The touch sensitive functionality of the button enables the safe and comfortable operation of devices.

Due to their functional principle, touch devices basically show a diverse responsiveness to different materials. Therefore all touch-buttons can be re-calibrated to match different glove types by an integrator on-site.

### Pressure sensitive Buttons



Pressure sensitive electronic buttons are absolutely immune to water on their touch surface. On top of that their responsiveness reduces unwanted activation caused when people lean against it.

These buttons are found in all areas where touch-buttons due to their way of operation, can not be used but the advantages of electronic buttons without movable parts are called for.

### Dual color LED-feedback



All buttons are equipped with bright LEDs. These show stand-by as well as operation.

The buttons are basically available in 3 series:

3-pole connection:

The status of the LEDs is handled by the button itself. It switches automatically between both statuses.

4-pole connection:

The device contains an auxiliary input to enable functionality of the button. When this one is active the stand-by indicator lights up.

The switch to operation LED takes place automatically.

5-pole connection:

These devices contain two auxiliary inputs from which both LEDs can be switched independently from each other, as well as independently from the operation of the button.

### Extreme lifespan



The consistent implementation of the full electronic design without movable parts, results in devices in which the wear can barely be determined.

## Shockproof



All versions of our devices, including the pressure sensitive models, are completely filled with resin. Due to this, they are not only remarkably shock resistant, they keep sand or similar small particles from entering.

## Vandalism proof design



All buttons and indicators have a housing made of stainless steel. The touch surface consists of shatterproof polycarbonate. The same material which bullet proof glass and shatterproof motor helm visors are made of.

## IO-Link



Devices which support IO-Link-Protocol have many advantages: For example, devices can be centrally managed and configured from a remote PLC. During the exchange, the device parameters are automatically restored. The advantage of this feature is that the standstill period is reduced to a minimum.

On top of all this the buttons can be individually configured by IO-Link. Configuration includes operation modes (dynamic, static, toggle) as well as the emulation of the LED control inputs.

## Housing models Ø22 mm



Buttons from the series Ø22 mm are available in different mechanical models:

Standard:

Modest design button made from stainless steel (1.3405).

Protector:

Derived from standard series but with an additional protective ring.

Flush:

Button made from stainless steel (1.3405) that can be flush mounted into materials with a thickness of up to 3 mm.

Hygienic:

Buttons with a bezel of stainless steel (1.4571) insure a strongly reduced angle of 35° to the mounting surface and therefore supports optimum residue free sanitation.

▼ **Dynamic Mode**

Buttons with dynamic operation are used when a precise single impulse is required to start a process; a typical example would be machine operation. The dynamic circuit ensures that the impulse is generated for long enough to be recognized by the machine, but no longer than necessary.

**3-pole**

LED management is handled solely by the switch. Activating the switch turns the 'idle' LED off and the 'engaged' LED on.

**4-pole**

The switch remains unlit as long as it has not been enabled by its corresponding input. Once the switch is enabled it turns the 'idle' LED on. Activating the switch turns the 'idle' LED off and the 'engaged' LED on.

**5-pole**

Both LEDs are decoupled from the status of the button. Each LED has its own control input which enables or disables it at any time.

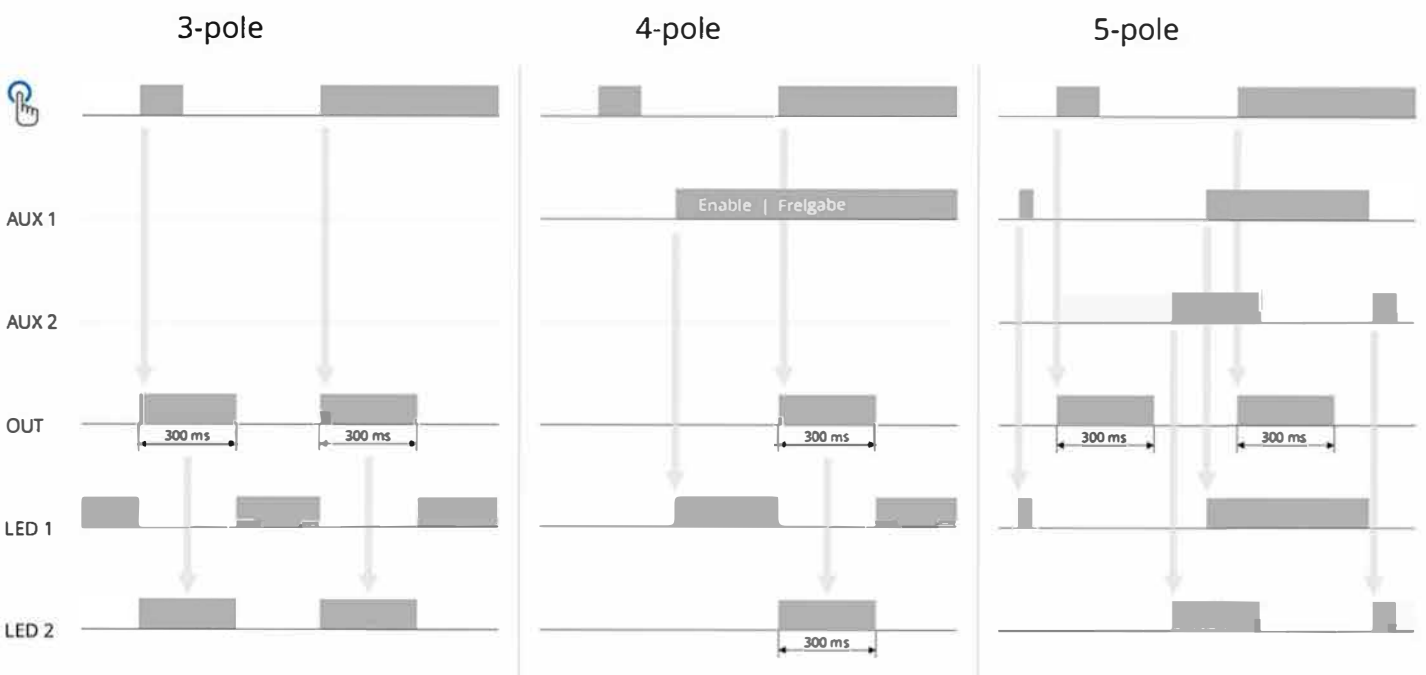

Any other impulse length is possible - just ask

▼ Static Mode

Buttons with static operation, activate their output as long as the operator touches or pushes the button. They behave like simple mechanical push buttons.

3-pole

LED management is handled solely by the switch. Activating the switch turns the 'idle' LED off and the 'engaged' LED on.

4-pole

The switch remains unlit as long as it has not been enabled by its corresponding input. Once the switch is enabled it turns the 'idle' LED on. Activating the switch turns the 'idle' LED off and the 'engaged' LED on.

5-pole

Both LEDs are decoupled from the status of the button. Each LED has its own control input which enables or disables it at any time.

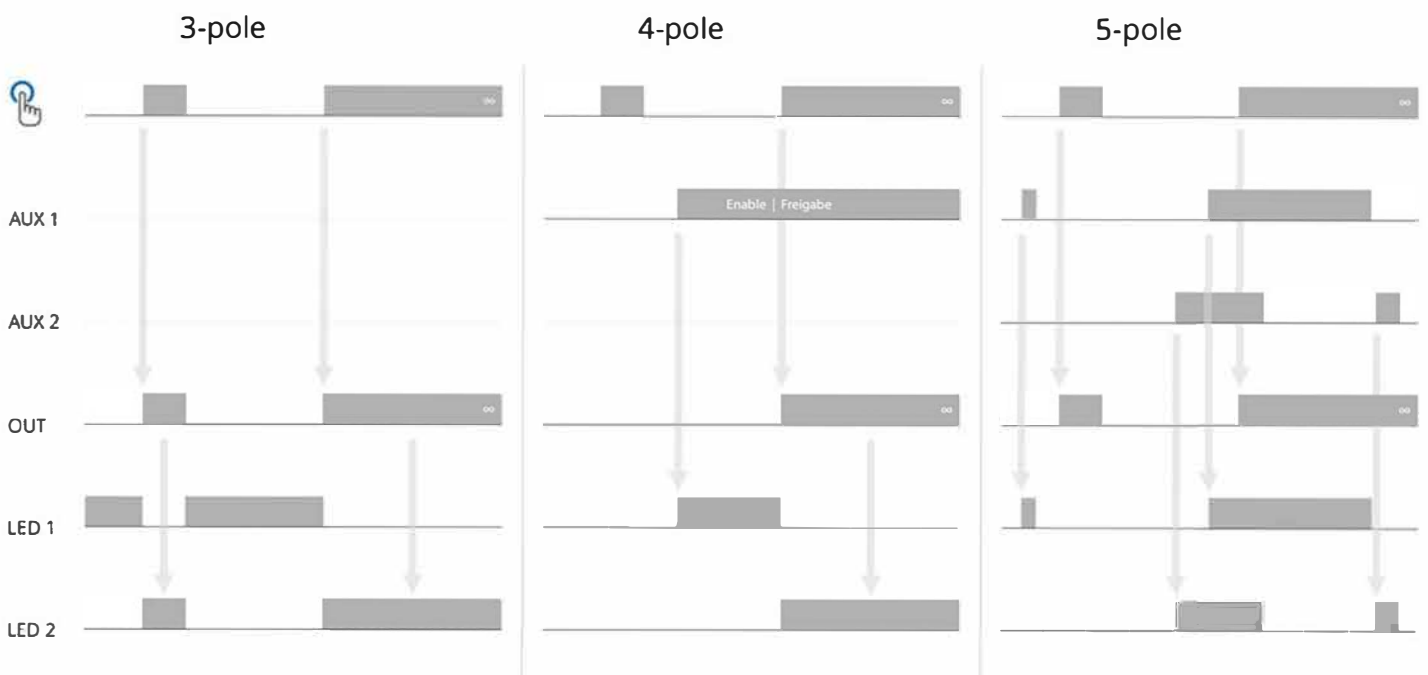



▼ Toggle Mode

Buttons with toggle circuit, alter their output status every time they are activated. The output status remains latched until the next activation. When restarting after a power outage, the default status of toggle-mode switches is the safe "OFF" mode, thus avoiding unwanted activation of switched devices.

3-pole

LED management is handled solely by the switch. Activating the switch turns the 'idle' LED off and the 'engaged' LED on.

4-pole

The switch remains unlit as long as it has not been enabled by its corresponding input. Once, the switch is enabled it turns the 'idle' LED on. Activating the switch turns the 'idle' LED off and the 'engaged' LED on.

5-pole

Both LEDs are decoupled from the status of the button. Each LED has its own control input which enables or disables it at any time.

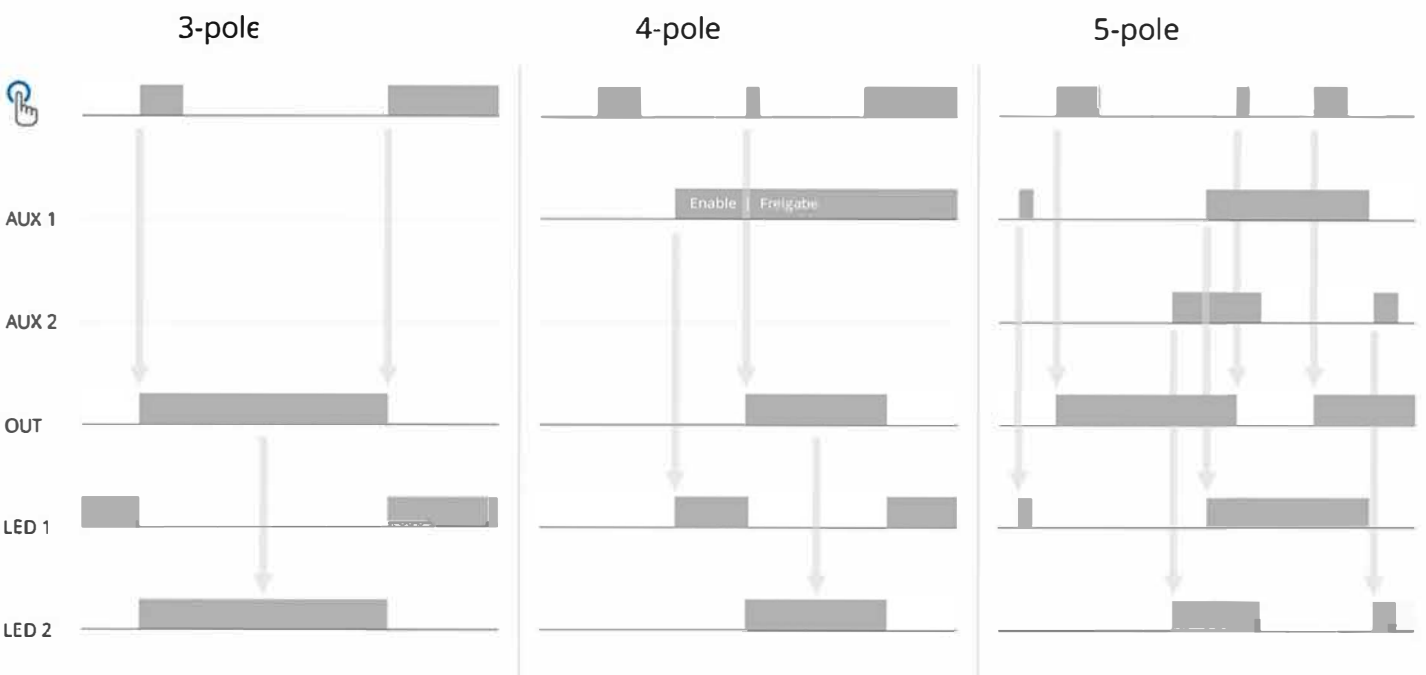

▼ Combo Mode

Buttons with combo circuit, can be used in static mode where the output is active if the button is touched or pushed. A fast double activation latches the button in a permanent on-mode from where it can be released by an additional activation. This mode was specifically designed to operate automatic doors or large gates that sometimes need to remain open for a longer period.

3-pole

LED management is handled solely by the switch. Activating the switch turns the 'idle' LED off and the 'engaged' LED on.

4-pole

The switch remains unlit as long as it has not been enabled by its corresponding input. Once the switch is enabled it turns the 'idle' LED off and the 'engaged' LED on. Activating the switch turns the 'idle' LED off and the 'engaged' LED on.

5-pole

Both LEDs are decoupled from the status of the button. Each LED has its own control input which enables or disables it at any time.

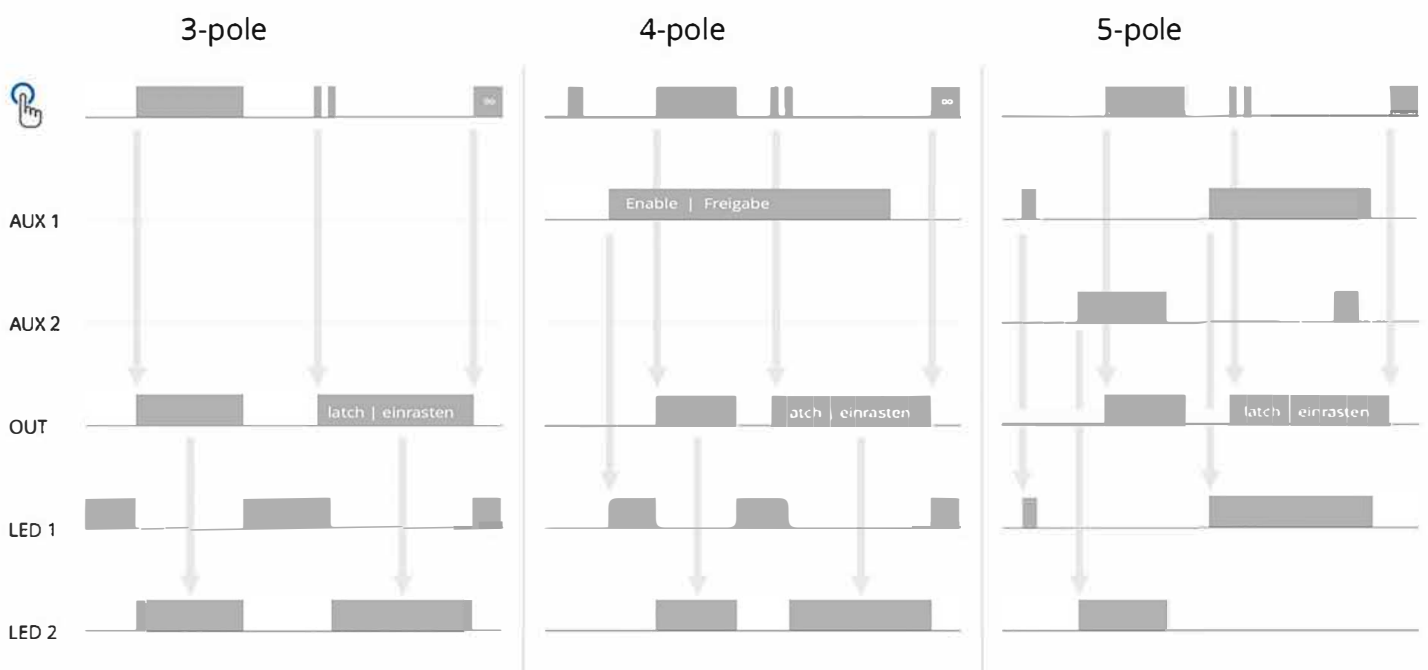

▼ Ø22 - Standard

Connector M8

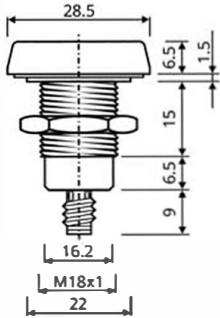

Strands

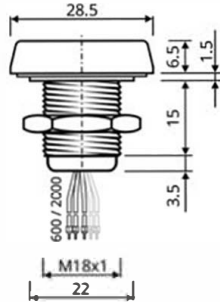

Cable

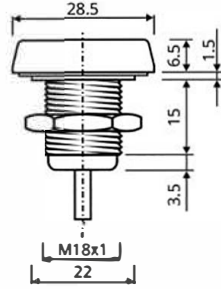

Terminal

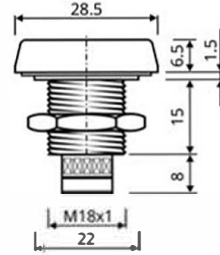

available as touch or push button and 7-color LED-indicator  
all dimensions are in mm

▼ Ø22 - Protector

Connector M8

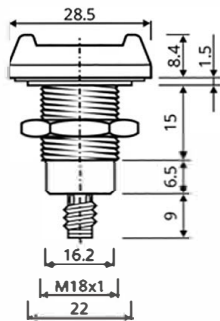

Strands

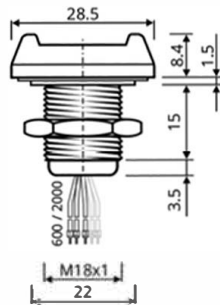

Cable

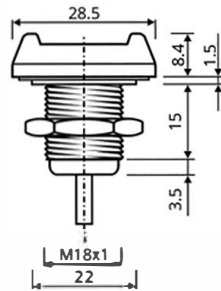

Terminal

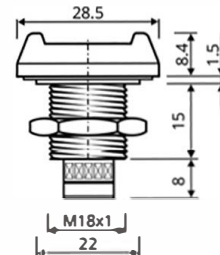

available as touch or push button and 7-color LED-indicator  
all dimensions are in mm

▼ Ø22 - Flush

Connector M8

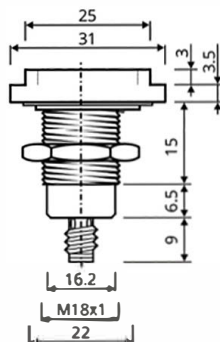

Strands

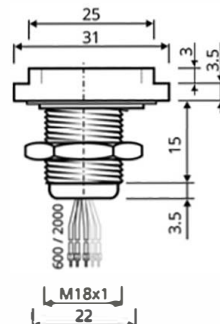

Cable

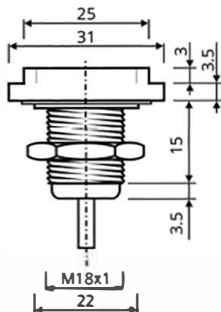

Terminal

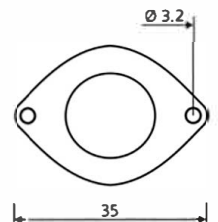
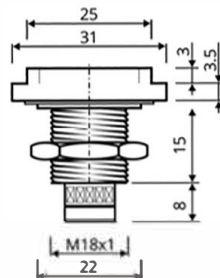

available as touch or push button and 7-color LED-indicator  
all dimensions are in mm

▼ Ø22 - Hygienic

Connector M8

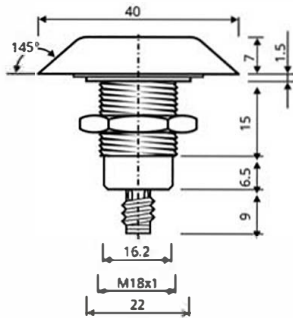

Strands

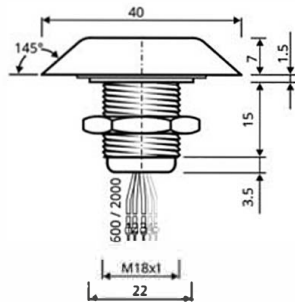

Cable

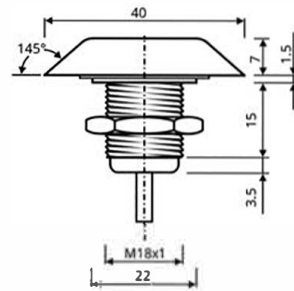

Terminal

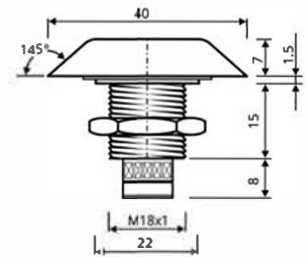

available as touch or push button and 7-color LED-indicator  
all dimensions are in mm

▼ Ø46 - Standard - touch-button

Connector M8

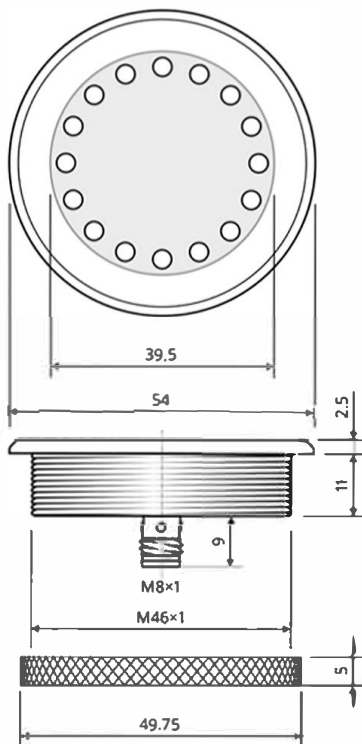

Strands

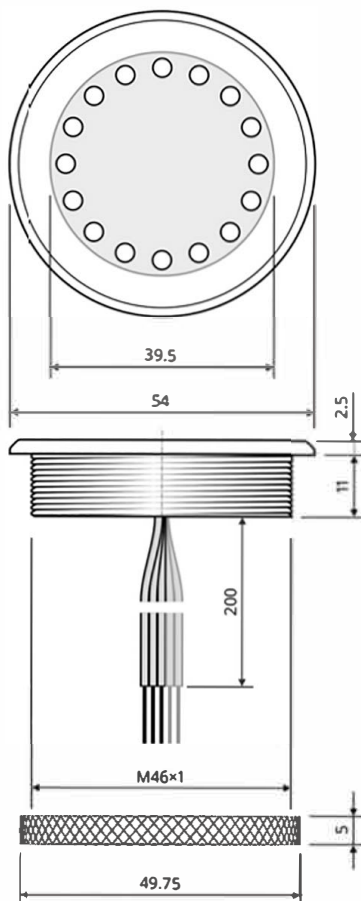

Cable

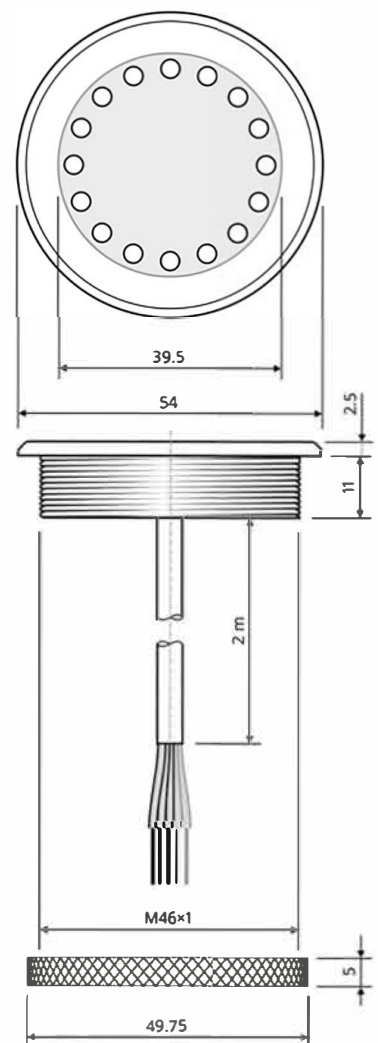

Technical Specifications		CE
Number of Operations	Unlimited	
Operating Voltage	15... 35 Vdc	
Reverse Polarity Protection	built-in	
Current Consumption	< 30 mA @ 24 V	
Current Load Capability	200 mA	
Short Circuit Protection	built-in - self-resetting	
Input Voltage NPN	0... 0.33 x Vcc	
Input Voltage PNP	0.66 x Vcc... Vcc	
Indicator Type	High Efficient LED	
Operating Temperature	-25... +60 °C	
IP Class Front	Ø22: IP67   Ø46: IP69k	
IP Class Back	IP67	
IK Class Front	Ø22: Ik10   Ø46: Ik09	
Sensing Face Material	Polycarbonate	
Housing Material	Stainless Steel '1.4305'	
Bezel Material	Stainless Steel '1.4305' * Hygienic '1.4571'	

Internal schematics and external connections

3-pole connection:

The status of the LEDs is handled by the button itself. It switches automatically between both statuses.

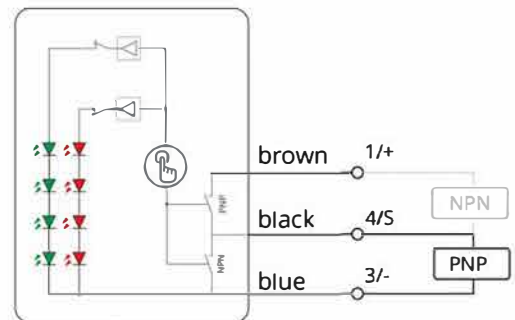

4-pole connection:

The device contains an auxiliary input to enable functionality of the button. When this one is active the stand-by indicator lights up. The switch to operation LED takes place automatically.

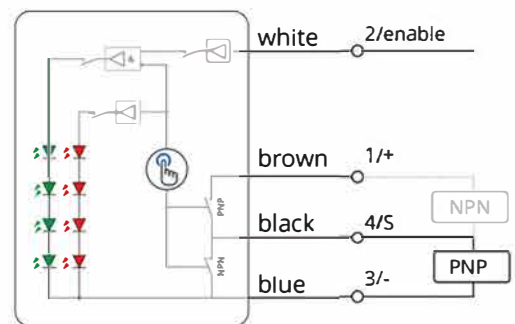

5-pole connection:

These devices contain two auxiliary inputs from which both LEDs can be switched independently from each other, as well as independently from the operation of the button.

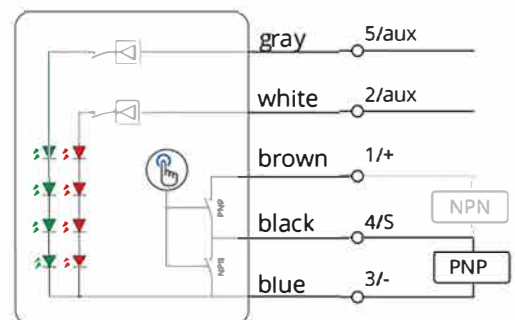

Intelligent Buttons

TS 22 D - 3 P O G R - N8 #1

Housing

22  
46

Page 9-10

Wires / Leitungen

3 3-pole

4 4-pole, Enable

5 5-pole, 2x LED

Page 7-10-13

Colors idle | engaged

GR Green | Red

BR Blue | Red

WG White | Green

WR White | Red

Page 8

Symbol

Page 4

Page 14

Prefix

See overview

Page 7-10

Function

D dynamic

S static

T toggle

C Combo

Page 6 (I/O - Link)

Output

PO PNP, NO

PC PNP, NC

NO NPN, NO

NC NPN, NC

IO IO-Link®

Page 11-12

Connection

N8 Connector M8

3N8 300 mm PUR, Connector M8

3N12 300 mm PUR, Connector M12

S200 PVC single strands, 200 cm

N2P PVC-Cable, 2m

TB5 Terminal block

Page 5

Default configuration for IO-Link® is: static operation, 3-pole, green-red. All parameters can be changed on protocol level.

**Prefix**

- TS Touch Sensitive, Standard
- TP Touch Sensitive, Protector
- TF Touch Sensitive, Flush mount
- TH Touch Sensitive, Hygienic )\*
  
- PS Pressure Sensitive, Standard
- PP Pressure Sensitive, Protector
- PF Pressure Sensitive, Flush mount
- PH Pressure Sensitive, Hygienic

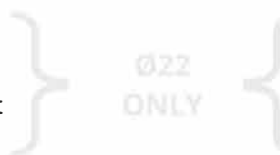

)\* Note: Touch sensitive buttons are sensitive against water on their touch surface. Keep that in mind when you decide for this type.